



CR-V

Backup Sensors User's Information





Contents

Introduction	3
Important Information	4
How the Backup Sensors Work	5
Limitations	8
Operation	10
Daily Inspection.....	12
Caring for the Backup Sensors.....	13
Troubleshooting.....	14





Introduction

Thank you for purchasing this Honda accessory.

Please read this User's Information carefully before using the backup sensors, and keep this manual in the glove box for future reference.

This product is designed to be used exclusively on an Honda CR-V. Honda is not responsible if the unit is used for any other intended purpose.

This User's Information should be considered a permanent part of the vehicle. It should remain with the vehicle at all times and stay with the vehicle when sold.

This accessory should be installed only by a skilled technician who has the proper tools, equipment, and training to correctly and safely add equipment to your vehicle. Installation should not be attempted by "do-it-yourselfers."

This User's Information contains important information about the safe operation of the backup sensors. We urge you to read this manual carefully, become familiar with the controls it describes, and follow its recommendations to help make your driving trouble-free and enjoyable.



Important Information

Before using the backup sensors, make sure you read and understand the operation and limitations of the system as discussed throughout this manual.

- The backup sensors are designed to provide an audible sound when they detect large stationary objects while the vehicle is moving in reverse at low speed. However, the system may not detect all objects depending on their size, shape, and location.
- Even with the backup sensors, the driver is still responsible for making sure the path is clear when driving in reverse.





How the Backup Sensors Work

Backup Sensors

The sensors are ready for operation when the shift lever is moved to the reverse position.

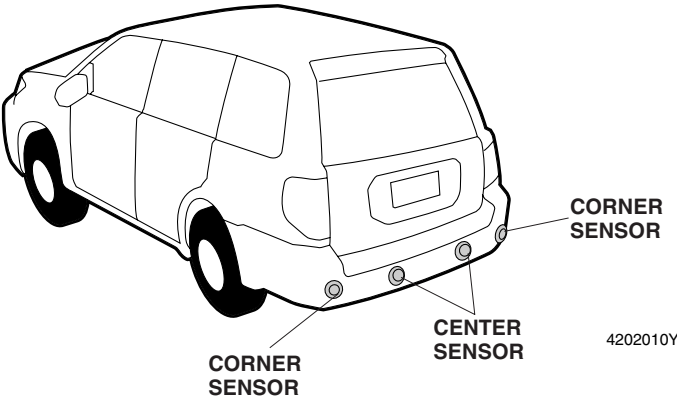

The sensors operate by emitting ultrasonic waves. They calculate the distance between the rear bumper and an obstacle by measuring the time the ultrasonic waves take to reach the sensor after being reflected by an obstacle.



How the Backup Sensors Work

The sensors are designed to give you an audible signal when the rear bumper is approaching an obstacle.

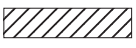
- The audible signal has three sounds:

Sound	Corner Sensors	Center Sensors	Fill Pattern
Slow intermittent beeps	Within 2.0 feet (60 cm)	Within 4.9 feet (150 cm)	
Quick intermittent beeps	Within 1.5 feet (45 cm)	Within 3.3 feet (100 cm)	
Continuous beep	Within 1.0 foot (30 cm)	Within 1.6 feet (50 cm)	

Corner Sensors:

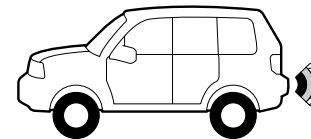
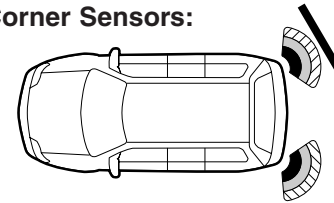

Center Sensors:

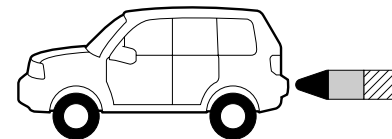
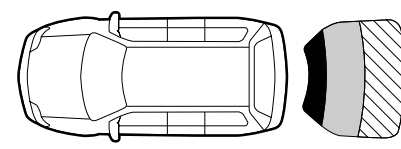

4709010Y



How the Backup Sensors Work

The sensors detect the closest rear obstacle.

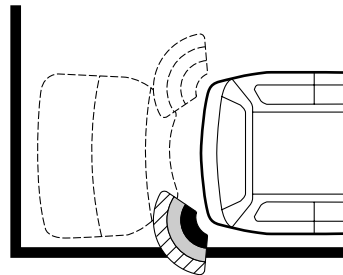

In this example, the corner sensor detects the side wall.

The sensors may not detect the rear bumper of tall vehicles.

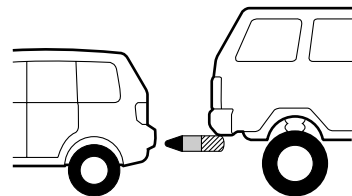

The system can be turned on/off by operating the switch of the buzzer.

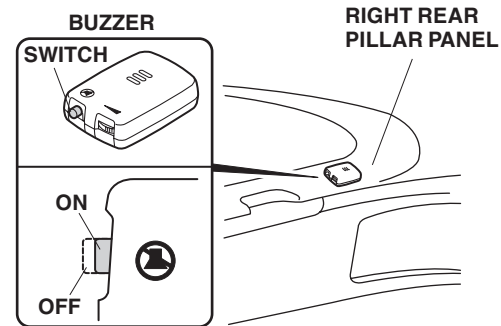

6612390B



Limitations

The sensors may not work if the obstacle is an odd shape or made of material that does not reflect ultrasonic waves.

Examples:



POLE



RECTANGULAR LUMBER



CARDBOARD CARTON



BICYCLE TIRE



SMALL TREE

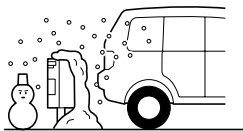

SOFT SNOW AND OTHER ABSORBENT OBJECTS

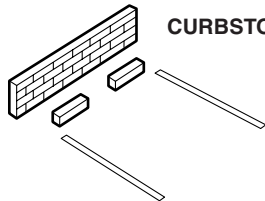

CURBSTONE



WIRE, ROPE, AND NET FENCE 4202030Y

The sensors may not work if the ambient air temperature is below -4°F (-20°C) or above 122°F (50°C).

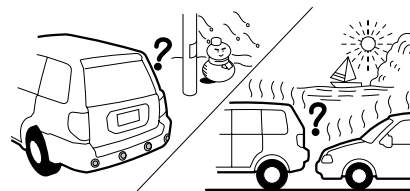

4202020Y

The audible signal may sound a warning even if there is no obstacle behind the vehicle:

- Water frozen on the sensor

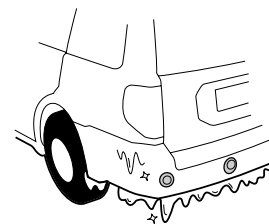

4202040Y



Limitations

The audible signal may sound warning even if there is no obstacle behind the vehicle:

- Sensors clogged with snow, dirt or mud

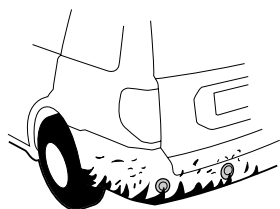

4202050Y

The sensors may sound continuously under the following conditions:

- When driving on rough surfaces or gravel roads or in grass, or when stopped on a hill

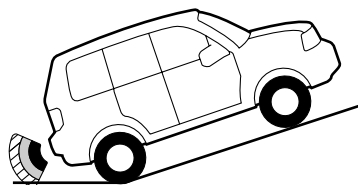

- When the vehicle is equipped with a high-power radio and antenna

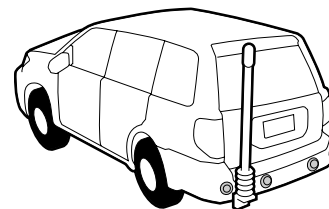

4202060Y

- When detecting loud noises such as a vehicle horn, a motorcycle's engine, or air brakes

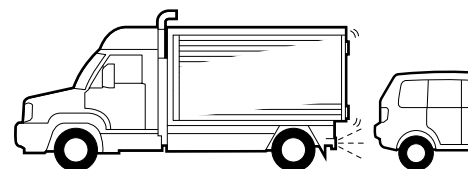

- When driving in rain or melted snow

Operation

Before using the backup sensors, become familiar with the types of sounds in relation to the distances between the sensors and the obstacle by actually backing your vehicle into a garage or parking space. Also confirm the obstacle detecting range of each backup sensor.

1. Apply the parking brake.
2. Turn the ignition switch to ON (II), but not start the engine yet.

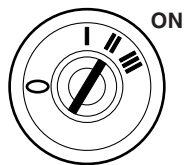

3. Move the shift lever to reverse.

4. With one of the doors open, check that the audible signal sounds by slowly bringing the palm of your hand close to each sensor as described:

For the corner sensors:
From 2.0 feet (60 cm)

For the center sensors:
From 4.9 feet (150 cm)

Confirm that the sound of the corner sensors is different from that of the center sensors.

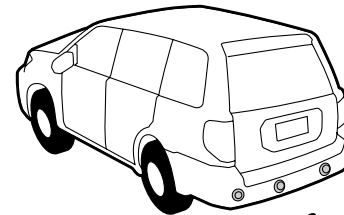

Confirm the obstacle detecting range of each sensor.



4202080Y



Operation

5. Check that the intermittent warning beeps become quicker as you bring the palm of your hand closer to the sensor.

For the corner sensors:
About 1.5 feet (45 cm)

For the center sensors:
About 3.3 feet (100 cm)

6. Check that the intermittent warning beeps change to a continuous beep as you bring the palm of your hand closer to the sensor. It may stop making noise or emit intermittent beeps if you move your hand closer too quickly.

For the corner sensors:
About 1.0 foot (30 cm)

For the center sensors:
About 1.6 feet (50 cm)

7. The sound volume can be adjusted by turning the dial of the buzzer.

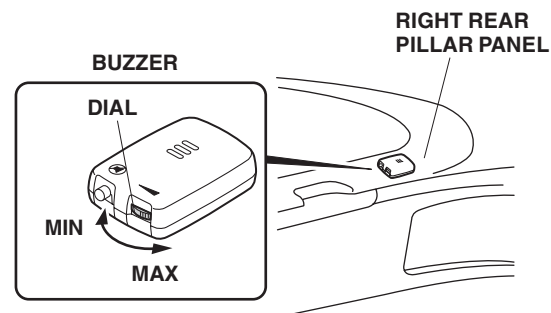

6612400B

8. Turn the ignition switch to OFF (0).



Daily Inspection

1. Turn the ignition switch to ON (II), and apply the parking brake.
2. Depress the brake pedal, and move the shift lever to the reverse position. Check that the audible signal sounds for about one second.
 - The sensors are normal if the audible signal sounds for about one second.
 - If the audible signal keeps sounding, this is an indication that the sensors are frozen or clogged with mud, dirt, etc. If the sensors are clean but keep sounding, there is an abnormality in the circuit. See your Honda dealer when possible.

Be careful not to confuse the sound of the sensors with those of other components or systems.





Caring for the Backup Sensors

Wipe the sensors clean with a clean cloth, or flush with low-pressure water if they are clogged with mud and dirt.

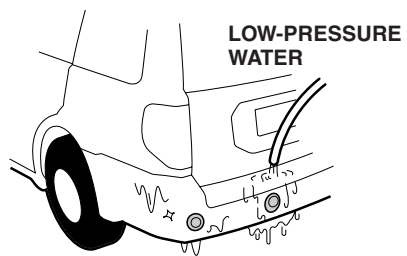

4202090Y

Do not spray high-pressure water against the sensors.

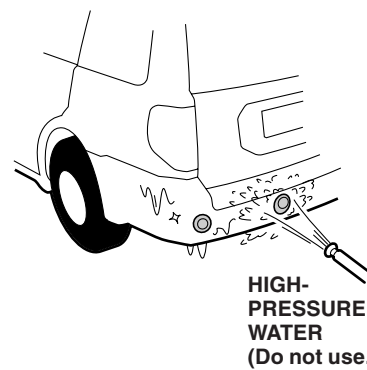

4202100Y

Troubleshooting

Perform the following checks if the audible signal does not sound when the vehicle is approaching an obstacle.

Symptom	Remedy
<ul style="list-style-type: none">• Clogged sensor with snow or mud	<ul style="list-style-type: none">• Wipe with a clean cloth or flush with low-pressure water.
<ul style="list-style-type: none">• Frozen sensor	<ul style="list-style-type: none">• Melt with lukewarm water
<ul style="list-style-type: none">• Extended parking in cold weather or under blazing sun	<ul style="list-style-type: none">• The backup sensors may not work if the outside air temperature is below -4°F (-20°C) or above 122°F (50°C).

Ask your Honda dealer for advice if the trouble persists.

Take your vehicle to your Honda dealer if you encounter either of these problems:

- The audible signal sounds continuously when the shift lever is in the reverse position, and the sensors are not frozen or clogged with snow or mud.
- The audible signal does not sound when the shift lever is in the reverse position.



Troubleshooting

Troubleshooting With Beeps

When you turn the ignition switch to ON (II), and the backup sensor signal sounds more than once, there may be a problem with one of the sensors.

Corner Sensors

Two fast beeps: right sensor is faulty.

Three fast beeps: left sensor is faulty.

Four fast beeps: right and left sensors are faulty.

Center Sensors

Two slow beeps: right sensor is faulty.

Three slow beeps: left sensor is faulty.

Four slow beeps: right and left sensors are faulty.





HONDA
The Power of Dreams



08V67-SWA-1000-81

© 2006 American Honda Motor Co., Inc. - All Rights Reserved.

Printed in Taiwan

